



PYLONTECH

Lithium-Ion Phosphate Battery PowerCube-H2 Product Manual

This manual introduces PowerCube-H2 from Pylontech. PowerCube-H2 is a high voltage Lithium-Ion Phosphate Battery storage system. Please read this manual before you install the battery and follow the instruction carefully during the installation process. Any confusion, please contact Pylontech immediately for advice and clarification.

Contents

| | |
|--|-----------|
| 1. SAFE HANDLING OF LITHIUM BATTERIES GUIDE | 2 |
| Before Connecting | 2 |
| In Using..... | 2 |
| 2. INTRODUCTION | 4 |
| 2.1 features..... | 4 |
| 2.2 Specifications..... | 5 |
| 2.2.1 The parameter of system..... | 5 |
| 2.2.2 Battery Module..... | 7 |
| Battery Module Front Interface | 8 |
| 2.2.3 Control Module (internal power supply)..... | 9 |
| Definition of RJ45 Port Pin | 10 |
| LED Indicators Instructions..... | 11 |
| 2.2.4 3 rd Level Control Module (MBMS) | 12 |
| Under CAN Communication Mode between MBMS and BMS (battery string qty. ≤ 6 set) | |
| | 13 |
| Definition of RJ45 Port Pin | 14 |
| LED Indicators Instructions..... | 14 |
| 3. EMERGENCY SITUATIONS | 15 |

1. Safe handling of lithium batteries Guide



Warning: This product is a high voltage DC system, operated by authorized person only.



Before installation or operation you must read <Operation Menu> carefully.



Warning

Before Connecting

- 1) After unpacking, please check product and packing list first, if product is damaged or lack of parts, please contact with the local retailer;
- 2) Before installation, be sure to cut off the grid power and make sure the battery is in the turned-off mode;
- 3) Wiring must be correct, do not mistake the positive and negative cables, and ensure no short circuit with the external device;
- 4) It is prohibited to connect the battery and AC power directly;
- 5) Battery system must be well grounded and the resistance must be less than 1Ω ;
- 6) Please ensured the electrical parameters of battery system are compatible to related equipment;
- 7) Keep the battery away from water and fire.

In Using

- 1) If the battery system needs to be moved or repaired, the power must be cut off and the battery is completely shutdown;
- 2) It is prohibited to connect the battery with different type of battery.
- 3) It is prohibited to put the batteries working with faulty or incompatible inverter;
- 4) It is prohibited to disassemble the battery (QC tab removed or damaged);
- 5) In case of fire, only dry powder fire extinguisher can be used, liquid fire extinguishers are prohibited;
- 6) Please do not open, repair or disassemble the battery except staffs from Pylontech or authorized by Pylontech. We do not undertake any consequences or related responsibility which because of violation of safety operation or violating of design, production and equipment safety standards.



Reminded

- 1) Please read the user manual carefully (in the accessories);
- 2) If the battery is stored for long time , it is required to charge them every six months, and the SOC should be no less than 80%;
- 3) Battery needs to be recharged within 12 hours, after fully discharged;
- 4) Do not expose cable outside;
- 5) All the battery terminals must be disconnected for maintenance;
- 6) Please contact the supplier within 24 hours if there is something abnormal.
- 7) The warranty claims are excluded for direct or indirect damage due to items above.

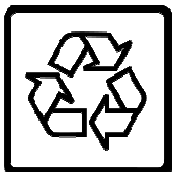

Li-ion



2. Introduction

PowerCube-H2 is a high voltage battery storage system based on lithium iron phosphate battery, is one of new energy storage products developed and produced by Pylontech, it can be used to support reliable power for various types of equipments and systems. PowerCube-H2 is especially suitable for application scene of high power, limited installation space, restricted load-bearing and long cycle life.

PowerCube-H2 has 3 levels BMS (battery management system), which can manage and monitor cells information including voltage, current and temperature. What's more, BMS can balance cells charging and discharging to extend cycle life. Multiple batteries can connected in parallel to expand capacity and power in parallel for larger capacity and longer power supporting duration requirements.

2.1 features

- The whole module is non-toxic, non-polluting and environmentally friendly;
- Cathode material is made from LiFePO₄ with safety performance and long cycle life;
- Battery management system (BMS) has protection functions including over-discharge, over-charge, over-current and high/low temperature;
- The system can automatically manage charge and discharge state and balance current and voltage of each cell;
- Flexible configuration, multiple battery modules can be in serial for expanding voltage and Capacity.
- Adopted self-cooling mode rapidly reduced system entire noise;
- The module has less self-discharged, up to 6 months without charging ion shelf; no memory effect, excellent performance of shallow charge and discharge;
- Working temperature range is from 0°C to 50°C, with excellent discharge performance and cycle life;
- Small size and light weight, standard of 19-inch embedded designed module is comfortable for installation and maintenance;

Caution: PowerCube-H2 without soft-start circuit. So must choose the inverter, which has soft-start function, otherwise has the risk of equipment breakdown.

2.2 Specifications

2.2.1 The parameter of system



| No. | Product Type | POWERCUBE-H2 (576V74AH) |
|-----|---|----------------------------|
| 1 | Cell Technology | Li-ion(LFP) |
| 2 | Battery System Capacity(kWh) | 42.624 |
| 3 | Battery System Voltage(Vdc) | 576 |
| 4 | Battery System Capacity(AH) | 74 |
| 5 | Battery Controller Name | SC1000-100 |
| 6 | Battery Module Name | H48074 |
| 7 | Battery Module Quantity(pcs) | 12 |
| 8 | Battery Module Capacity(kWh) | 3.552 |
| 9 | Battery Module Voltage(Vdc) | 48 |
| 10 | Battery Module Capacity(AH) | 74 |
| 11 | Battery Module Cell Quantity(pcs) | 15 |
| 12 | Battery System Charge Upper-Voltage(Vdc) | 648 |
| 13 | Battery System Charge Current(Standard) | 14.8 |
| 14 | Battery System Charge Current(Normal) | 37 |
| 15 | Battery System Charge Current(Max.) | 74 |
| 16 | Battery System Discharge lower-Voltage(Vdc) | 540 |
| 17 | Battery System Discharge Current(Standard) | 14.8 |
| 18 | Battery System Discharge Current(Normal) | 37 |
| 19 | Battery System Discharge Current(Max.) | 74 |
| 20 | Efficiency | 96% |
| 21 | Depth of Discharge | 80%(10~90%) |
| 22 | Dimension(W*D*H, mm) | 600*505*2130 |
| 23 | Communication | RS485\CAN |
| 24 | Protection Class | IP20 |
| 25 | Weight (kg) | 460.5 |
| 26 | Operation Life(Years) | 10 |
| 27 | Operation Cycle Life | 3500 |
| 28 | Operation Temperature(°C) | 0~50 |
| 29 | Storage Temperature(°C) | -20~60 |
| 30 | Product Certificate | TÜV, CE |
| 31 | Transfer Certificate | UN38.3 |
| 32 | Other: 1) Battery Controller Dimensions(W*D*H) 2) Battery Module Dimensions (W*D*H) | 442*390*132 442*390*132 |

Remark: The parameter will be changed when the battery modules in different series (5~12 pcs battery modules).

2.2.2 Battery Module



| No. | Product Type | H48074 |
|-----|---|--------------|
| 1 | Cell Technology | Li-ion(LFP) |
| 2 | Battery Module Capacity(kWh) | 3.552 |
| 3 | Battery Module Voltage(Vdc) | 48 |
| 4 | Battery Module Capacity(AH) | 74 |
| 5 | Battery Cell Quantity(pcs) | 30 |
| 6 | Battery Cell Capacity(Wh) | 118.4 |
| 7 | Battery Cell Voltage(Vdc) | 3.2 |
| 8 | Battery Cell Capacity(AH) | 37 |
| 9 | Battery Module Cell Quantity in Series(pcs) | 15 |
| 10 | Battery Module Charge Upper-Voltage(Vdc) | 54 |
| 12 | Battery Module Charge Current(Standard)(A) | 14.8 |
| 13 | Battery Module Charge Current(Normal)(A) | 37 |
| 14 | Battery Module Charge Current(Max.)(A) | 74 |
| 15 | Battery Module Discharge lower-Voltage(Vdc) | 45 |
| 16 | Battery Module Discharge Current(Standard)(A) | 14.8 |
| 17 | Battery Module Charge Current(Normal)(A) | 37 |
| 18 | Battery Module Charge Current(Max.)(A) | 74 |
| 19 | Efficiency | 96% |
| 20 | Depth of Discharge | 80% (10~90%) |
| 21 | Dimension(W*D*H, mm) | 442*390*132 |
| 22 | Communication | RS485\CAN |
| 23 | Protection Class | IP20 |
| 24 | Weight(kg) | 32 |
| 25 | Operation Life(Years) | 10 |
| 26 | Operation Cycle Life | 4000 |
| 26 | Operation Temperature(°C) | 0~50 |
| 27 | Storage Temperature(°C) | -20~60 |
| 29 | Product Certificate | TÜV, CE |
| 30 | Transfer Certificate | UN38.3 |

Battery Module Front Interface



Power Terminal +/-

To connect battery series power cables.

Status

Status light: to show the battery module's status (RUN ●, Alarm ● and Protection ●).

RS232 Terminal

Console Communication Terminal: (RJ45 port) follow RS232 protocol, for manufacturer or professional engineer to debug or service.

Link Port 0, 1

Link Port 0, 1 Communication Terminal: (RJ45 port) follow RS485 protocol, for communication between multiple serial battery modules and control module.

Power Terminals

Power cable terminals: there are two pair of terminals with same function, one connect to equipment, the other one paralleling to other battery module for capacity expanding. For each single module, each terminal can achieve charging and discharging function.

For power cables uses water-proofed AMPHENOL connectors. It must keep pressing this Lock Button during pulling out the power plug.

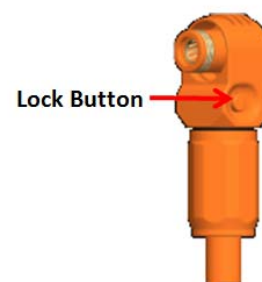

2.2.3 Control Module (internal power supply)

Control Module has two types: **internal** and **external** power supply.

Control Module (SC1000-100S) Front Interface

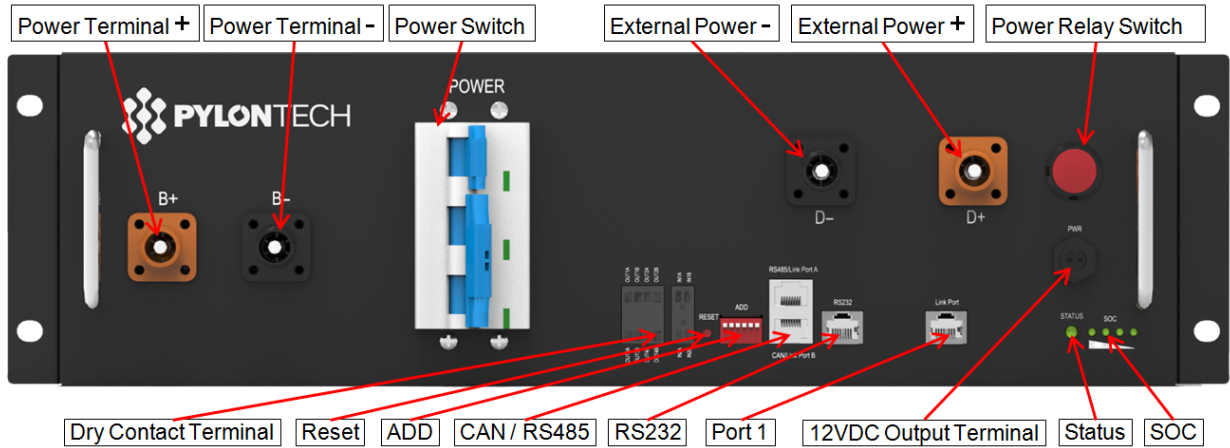

Power Terminal +/-

To connect battery power cables in series.

Power Switch

Switch the battery system's (control module and high voltage DC power) ON/OFF.



Caution: When the breaker is tripped off because of over current or short circuit, must wait after 30min to turn on it again, otherwise may cause the breaker damage.

External Power Terminal +/-

Connect battery system with Inverter.

Power Relay Switch

Normally it turns in ON position, can't turn it OFF during normal running condition.



Warning: This Power Relay Switch must be sure turned ON. Otherwise it will affect automatic checking process and causes danger.

Danger: DO NOT turn off the "Power Relay Switch" during normal running condition, only in emergency case it could be turned off directly. Otherwise will cause this battery string current surge by another battery strings.

12VDC Output Terminal

Power supply for 3rd level control module, with 12VDC cable:

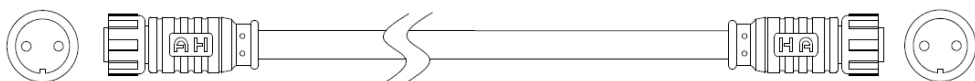

Dry Contact Terminal

Dry Contact Terminal: provided 2 input and 4 output dry contact signal.

Reset

Reset Button: Long press this button to restart the battery system.

ADD

ADD: 6 bit dial switches to manually distribute the communication address of the battery system. Nether position is OFF, means "0". Upper position is ON, means "1". 1st bit to 5th bit is for address, and the 6th bit dial switch support a 120 Ω resistance.

CAN / RS485

CAN Communication Terminal: (RJ45 port) follow CAN protocol, for communication between battery system and inverter.

RS485 Communication Terminal: (RJ45 port) follow RS485 protocol, for communication between battery system and inverter.

RS232 Terminal

Console Communication Terminal: (RJ45 port) follow RS232 protocol, for manufacturer or professional engineer to debug or service.

Link Port 0, 1

Link Port 0, 1 Communication Terminal: (RJ45 port) follow RS485 protocol, for communication between multiple serial battery modules and control module.

Definition of RJ45 Port Pin

| No. | CAN | RS485 | RS232 Pin |
|-----|------|--------|-----------|
| 1 | --- | --- | --- |
| 2 | GND | --- | --- |
| 3 | --- | --- | TX |
| 4 | CANH | --- | --- |
| 5 | CANL | --- | --- |
| 6 | --- | GND | RX |
| 7 | --- | RS485A | --- |
| 8 | --- | RS485B | GND |

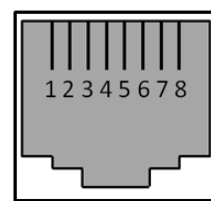

RJ45 Port

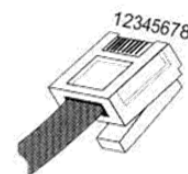

RJ45 Plug







Status

Status light: to show the battery module's status (RUN ●, Alarm ● and Protection ●).

LED Status Indicators

- ✧ Battery capacity indicator (No.8 Figure 2-1): 4 green lamps, each light represent 25% capacity.

LED Indicators Instructions

| Battery Statuses | Protection / Alarm / Normal | RUN | ALM | PRC | Capacity SOC | | | | Descriptions |
|------------------|-----------------------------|---|---|---|---|---|--|---|---|
| | |  |  |  |  |  |  |  | |
| Shut Down | | Off | Off | Off | Off | Off | Off | Off | All off |
| Sleep | Normal | Flash 1 | Off | Off | Off | Off | Off | Off | Indicates Sleep Mode, to save the power. |
| Standby | Normal | Flash 1 | Off | Off | Off | Off | Off | Off | Indicates save power mode. |
| | Alarm | Off | Light | Off | Off | Off | Off | Off | Indicates the battery is low. |
| Standby | Normal | Flash 1 | Off | Off | Off | Off | Off | Off | Indicates Standby |
| Charge | Normal | Light | Off | Off | The highest capacity indicator LED flashes (flash 2), others lighting | | | | The highest capacity indicator LED flashes (flash 2), others lighting |
| | Alarm | Off | Light | Off | | | | | |
| | Protection | Off | Off | Light | Off | Off | Off | Off | Stop charging, PRC lighting |
| Discharge | Normal | Flash 3 | Off | Off | Indicate based on capacity | | | | Indicate based on capacity |
| | Alarm | Off | Light | Off | | | | | Stop discharging, PRC lighting |
| | Protection | Off | Off | Light | | | | | |
| Abnormal | Protection | Off | Off | Light | Off | Off | Off | Off | Stop charging/discharging, PRC lighting |

Note: The flashing instructions, flash 1 - light 0.25s / off 3.75 seconds; flash 2 - 0.5s light / 0.5s off; flash 3 - 0.5s light / 1.5s off.

2.2.4 3rd Level Control Module (MBMS)

MBMS is the controller for multiple battery piles in parallel connection.

If the power supply is 220Vac, an adaptor (220Vac to 12Vdc) will be provided.



| Serial Number | Product Model | MBMS1000 |
|---------------|------------------------------|--------------------------|
| 1 | Operating voltage range | 12 Vdc |
| 2 | Communication interface | CAN*2/RS485*2/Ethernet*2 |
| 3 | Output dry contact interface | 4 groups |
| 4 | Input dry contact interface | 2 groups |
| 5 | System Consumption | 2W |
| 6 | Size | 442*190*44mm |
| 7 | Protection degree | IP20 |
| 8 | Weight (kg) | 5 |
| 9 | Working temperature | -20~60°C |
| 10 | Storage temperature | -40~80°C |

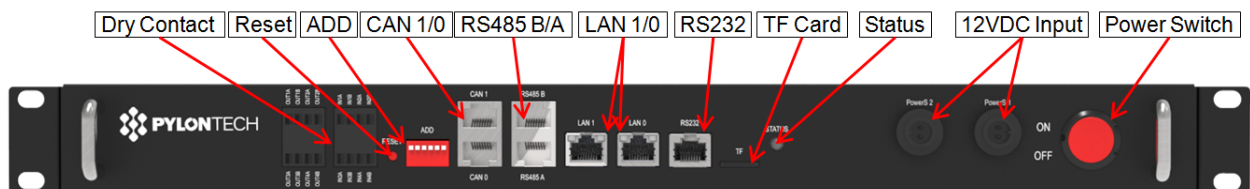

12VDC Input

Take 12VDC power from outside (from control module or AC/DC adaptor).



Dry Contact Terminal

Dry Contact Terminal: provided 4 ways input and 4 ways output dry contact signal.

Reset

Reset Button: Long press this button to restart the battery system.

Reset

Under CAN Communication Mode between MBMS and BMS (battery string qty. ≤6 set)

The MBMS's ADD Switch shall set as "1000X₁X₀" with 1st bit at '1' always. The last 2 bits are terminal resistances;

X₁ address should correspond with CAN1 port connection, X₀ address should correspond with CAN0 port connection.

When the external communication is via CANBUS, and if this equipment requires terminal resistance, then X₀/X₁ should be set to "1". If this equipment not require terminal resistance, then X₀/X₁ should be set to "0"; If there are multiple external devices communicate with MBMS via CANBUS, then the X₀/X₁ shall follow varying external device requirement.

The BMS's first five bits must set in below <BMS's Address Configure Table>. The last (farthest position) BMS's terminal resistance must set in "1" (X=1), and other BMS's terminal resistance must set in "0".

The address is configured follow ASCII code: ("X" is terminal resistance).

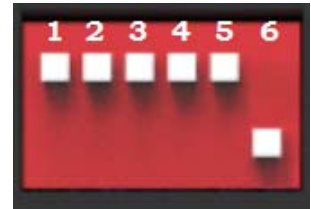

BMS's Address Configure Table:

| Battery String | Address Bit |
|----------------|-------------|
| 1 | 1000X |
| 2 | 0100X |
| 3 | 1100X |
| 4 | 0010X |
| 5 | 1010X |
| 6 | 0110X |

CAN 1/0

CAN

CAN Communication Terminal: (RJ45 port) follow CAN protocol, for communication between battery system and PCS.

RS485 B/A

RS485

RS485 Communication Terminal: (RJ45 port) follow RS485 protocol, for communication between battery system and PCS.

RS232

RS232

Console Communication Terminal: (RJ45 port) follow RS232 protocol, for manufacturer or professional engineer to debug or service.

Link Port

Link Port

Link Port Communication Terminal: (RJ45 port) follow RS485 protocol, for communication between multiple serial battery modules and control module.

Definition of RJ45 Port Pin

| No. | CAN | RS485 | RS232 Pin | Link Port Pin |
|-----|------|--------|-----------|---------------|
| 1 | --- | --- | --- | --- |
| 2 | GND | --- | --- | GND |
| 3 | --- | --- | TX | --- |
| 4 | CANH | --- | --- | CANH |
| 5 | CANL | --- | --- | CANL |
| 6 | --- | GND | RX | --- |
| 7 | --- | RS485A | --- | --- |
| 8 | --- | RS485B | GND | --- |

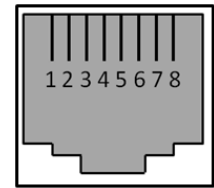

RJ45 Port

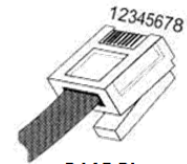

RJ45 Plug

Status

Status light: to show the battery module's status (RUN●, Protection●).

LED Status Indicators

✧ Battery capacity indicator: 4 green lamps, each light represent 25% capacity.

LED Indicators Instructions

| Battery Statuses | Protection / Alarm / Normal | RUN | PRC | Capacity SOC | | | | Descriptions |
|------------------|-----------------------------|--------|-------|---|-----|-----|-----|--------------------------------|
| | | ● | ● | ● | ● | ● | ● | |
| Shut Down | | Off | Off | Off | Off | Off | Off | All off |
| Sleep | Normal | Flash1 | | Off | Off | Off | Off | |
| | Alarm | | | Off | Off | Off | Off | |
| Standby | Normal | Flash1 | Off | Off | Off | Off | Off | Indicates Standby |
| Charge | Normal | Light | Off | The highest capacity indicator LED flashes (flash 2), others lighting | | | | |
| | Alarm | Off | Off | | | | | |
| | Protection | Off | Light | Off | Off | Off | Off | Stop charging, ALM lighting |
| Discharge | Normal | Flash3 | Off | Indicate based on capacity | | | | |
| | Protection | Off | Light | Off | Off | Off | Off | Stop discharging, ALM lighting |

Note: The flashing instructions, flash 1 - light 0.25s / off 3.75 seconds; flash 2 - 0.5s light / 0.5s off; flash 3 - 0.5s light / 1.5s off.

Power Switch

Turn ON/OFF the MBMS power, and ON/OFF the power output of external power of control modules.

3. Emergency Situations

1) Leaking Batteries

If the battery pack leaks electrolyte, avoid contact with the leaking liquid or gas. If one is exposed to the leaked substance, immediately perform the actions described below.

Inhalation: Evacuate the contaminated area, and seek medical attention.

Contact with eyes: Rinse eyes with flowing water for 15 minutes, and seek medical attention.

Contact with skin: Wash the affected area thoroughly with soap and water, and seek medical attention.

Ingestion: Induce vomiting, and seek medical attention.

2) Fire

NO WATER! Only dry powder fire extinguisher can be used; if possible, move the battery pack to a safe area before it catches fire.

3) Wet Batteries

If the battery pack is wet or submerged in water, do not let people access it, and then contact Pylontech or an authorized dealer for technical support.

4) Damaged Batteries

Damaged batteries are dangerous and must be handled with the utmost care. They are not fit for use and may pose a danger to people or property. If the battery pack seems to be damaged, pack it in its original container, and then return it to Pylontech or an authorized dealer.

NOTE

Damaged batteries may leak electrolyte or produce flammable gas. If such damage occurs, please contact Pylontech: service@pylontech.com.cn



PYLONTECH

Pylon Technologies Co., Ltd.

No. 73, Lane 887, ZuChongzhi Road, Zhangjiang Hi-Tech Park

Pudong, Shanghai 201203, China

T+86-21-51317697 | **F** +86-21-51317698

Eservice@pylontech.com.cn

Wwww.pylontech.com.cn