

# Installation Manual



Lithium Battery Pack

## SOLUNA 10K Pack HV

Suitable for indoor installation

**Soluna Australia Pty Ltd**

ACN 634 963 296

February 2021 Version 2.1

## About this manual

This manual describes how to install the **Soluna 10K PACK HV** battery system (hereafter referred to as 'the BS'). Please read the manual in its entirety **before** installing the BS and follow all instructions throughout the installation process.

If you are uncertain about any of the requirements, recommendations or safety procedures described in this manual, contact Soluna Australia immediately for advice and clarification.

Phone:            Within Australia    1300 126 888  
                     Outside Australia    +64 9886 9685

Email             [service@soluna.com.au](mailto:service@soluna.com.au)  
Web                [www.soluna.com.au](http://www.soluna.com.au)

Head office      1/677 Murray Street  
                     Perth WA 6005

The information included in this manual is accurate at the time of publication. However, with respect to product design and technical specification updates, Soluna Australia reserves the right to make changes at any time without prior notice. Further, the illustrations in this manual – which help explain system configuration concepts and installation instructions – may differ from the actual BS's appearance at the installation location.

Please search the technical section of [www.soluna.com.au](http://www.soluna.com.au) to ensure the Australian edition of the Installation Manual is the latest version. You must also complete the warranty registration form online at <https://soluna.com.au/warranty/>

### ***Version information***

Version	Date	Content	Author
1.0	04/02/21	10K Pack HV installation manual	GJ
2.0	08/02/21	10K Pack HV installation manual	JN
2.1	17/02/21	10K pack HV installation manual schematic diagrams	GJ











	<b>INSTALLATION MANUAL</b>	<b>1</b>
	LITHIUM BATTERY PACK	1
	SOLUNA 10K PACK HV	1
	SUITABLE FOR INDOOR INSTALLATION	1
	SOLUNA AUSTRALIA PTY LTD	1
	FEBRUARY 2021 VERSION 2.0	1
	ABOUT THIS MANUAL	2
<b>1.</b>	<b>SAFETY PRECAUTIONS</b>	<b>4</b>
	WARNINGS	4
	SAFETY INSTRUCTIONS	5
	GENERAL SAFETY PRECAUTIONS	5
	RISKS OF EXPLOSION	5
	RISKS OF FIRE	5
	RISKS OF ELECTRIC SHOCK	5
	RISKS OF DAMAGE TO THE BS	5
	BATTERY HANDLING GUIDE	5
	RESPONSE TO EMERGENCIES	6
	LEAKING BATTERIES	6
	FIRE	6
	WET BATTERIES	6
	DAMAGED BATTERIES	6
	ACCREDITED INSTALLERS	7
	SAFETY EQUIPMENT	7
<b>2.</b>	<b>PRODUCT INTRODUCTION</b>	<b>8</b>
	FEATURES	8
	APPLICATION	8
	UNPACKING THE BS	8
	PACKING LIST	9
	INSTALLATION MATERIALS	9
	INSTALLATION LOCATION	9
	INSTALLATION TOOLS	10
	OUTLINE DIMENSIONS (MM)	11
	TECHNICAL DATA	12
	APPEARANCE	13
	WIRING PORT	14
	REMARK	14
<b>3.</b>	<b>INSTALLATION</b>	<b>15</b>
	SPACE REQUIREMENTS DURING INSTALLATION AND OPERATION	15
	INSTALLATION REQUIREMENTS	16
	WIRING SPECIFICATION	16
	USE OF STANDARD COMMUNICATION CABLE WITH A SHIELDING FUNCTION IS RECOMMENDED.	16
	CAN COMMUNICATION INTERFACE (CAN 1 AND CAN 2)	17
	ELECTRICAL CONNECTION	18
	ELECTRICAL CONNECTION PROCEDURES	19
	OPERATING INSTRUCTIONS	23
<b>4.</b>	<b>CONSUMER 'START UP' AND 'SHUT DOWN' PROCEDURES</b>	<b>23</b>
<b>5.</b>	<b>CARE AND MAINTENANCE</b>	<b>25</b>
	FIRMWARE UPGRADE	25
<b>6.</b>	<b>TROUBLESHOOTING</b>	<b>26</b>
<b>7.</b>	<b>CONTACT US</b>	<b>26</b>

# 1. Safety precautions

## Warnings

Warning signs indicate conditions that may cause severe injury to the installer or damage to the BS, and that caution should be exercised to avoid danger. The following table describes the warning signs used in this manual.

Figure 1 – warning symbols.

Sign	Description
	This BS contains high-voltage materials that can cause an electric shock, resulting in severe injury.
	Ensure that battery polarity is observed, and that the BS is connected correctly.
	Keep the BS away from an open flame or sources of ignition.
	Keep children and animals away from the BS.
	Read the manual in its entirety before installing and operating the BS.
	The BS is heavy enough to cause severe injury if not handled correctly.
	The BS contains electrolyte, which is corrosive if it leaks.
	The BS may explode if not handled correctly.
	The BS should be recycled, not be disposed of with household waste, at the end of its working life. For more information, contact Soluna Australia.
	There is a risk of physical injury or damage to the BS if the installation requirements are not followed and/or the BS is mishandled.

## Safety instructions

For safety reasons, installers **must** familiarise themselves with this manual's contents and all warnings **before** installing the BS.

## General safety precautions



Please observe the precautions described in the following section. Failure to do so may result in serious injury to persons or animals or damage to property.

### Risks of explosion

- 1) Do not subject the BS to strong impacts.
- 2) Do not crush or puncture the BS.
- 3) Do not incinerate the BS.

### Risks of fire

- 1) Do not expose the BS to temperatures in excess of 60° Celsius.
- 2) Do not place the BS near a heat source such as a fireplace.
- 3) Do not expose the BS to direct sunlight.
- 4) Do not allow the BS connectors to touch conductive objects such as wires.

### Risks of electric shock

- 1) Do not disassemble the BS, as high DC voltage may be present.
- 2) Do not touch the BS with wet hands.
- 3) Do not expose the BS to moisture or liquids.
- 4) Keep children and animals away from the BS.

### Risks of damage to the BS

- 1) Do not allow the BS to come into contact with liquids.
- 2) Do not subject the BS to high pressures.
- 3) Do not place objects on top of the BS.

### Battery handling guide

- 1) Use the BS only as directed.
- 2) Do not use the BS if it is cracked, broken or otherwise damaged, or fails to operate.
- 3) Do not attempt to open, disassemble, repair, tamper with or modify the BS – it is not user-serviceable.
- 4) Handle the BS and its components with care to protect it from damage during transportation.
- 5) Do not strike, pull, drag or step on the BS.
- 6) Do not subject the BS to any strong force.
- 7) Do not insert foreign objects into any part of the BS.
- 8) Do not use solvents to clean the BS.

## Response to emergencies

The Soluna 10K PACK HV BS comprises multiple batteries that are designed in such a way as to prevent hazards resulting from failures. However, Soluna Australia cannot guarantee the absolute safety of the BS.

### Leaking batteries

If the BS leaks electrolyte, avoid contact with the leaking liquid or gas. The electrolyte is corrosive – contact with it may cause skin irritation and/or chemical burns. If a person/animal is exposed to the leaked substance, do the following.

- 1) Avoid inhalation of the leaked substance.
- 2) Evacuate the contaminated area and seek medical attention immediately.
- 3) Avoid eye contact with the leaked substance.
- 4) If eye contact occurs, rinse eyes with flowing water for 15 minutes and immediately seek medical attention.
- 5) Avoid skin contact with the leaked substance.
- 6) If the skin does come into contact with the leaked substance, wash the affected area thoroughly with soap and water and immediately seek medical attention.
- 7) Avoid ingestion of the leaked substance.
- 8) If ingestion does occur, induce vomiting and seek medical attention immediately.

### Fire

Always keep an ABC or carbon-dioxide fire extinguisher nearby in case of fire.



The BS may catch fire if heated above 150° Celsius.  
If there is a fire near or at the location in which the BS is installed, do the following.

- 1) If it is safe to do so, extinguish the fire before the BS ignites.  
If the BS does ignite, do not try to extinguish the fire; instead, call the fire brigade. Notify everyone and evacuate people and animals from the area immediately.



If the BS catches fire, it will produce noxious and very unpleasant gases – do not approach.

### Wet batteries

If the BS becomes wet or is submerged in water, stay out of the water and contact Soluna Australia or your distributor for technical assistance.

### Damaged batteries

Damaged batteries must be handled with extreme caution – they are not fit for use and may pose a danger to people, animals or property.

If the BS appears damaged, return it to its original container and contact Soluna Australia or your distributor for further instructions.



Damaged batteries may leak electrolyte or produce flammable gas. If you suspect such damage, immediately contact Soluna Australia for advice and information.

## Accredited installers



In Australia and New Zealand, the required standard is that of Clean Energy Council Accredited Installer, qualified to install battery storage systems connected to the grid.

This manual and the tasks and procedures described herein are intended for use only by such an accredited installer; that is, a trained and qualified electrician with the following skills and experience.

- 1) Knowledge of the functional principles and operation of on-grid systems.
- 2) Knowledge of the dangers and risks associated with installing and using electrical devices, as well as acceptable mitigation methods.
- 3) Knowledge of the installation of electrical devices.
- 4) Knowledge of and adherence to this manual, as well as all safety precautions and best practice.

## Safety equipment

The following safety gear should be worn when dealing with the BS.

Item	Photo	Name
1		Insulated gloves
2		Safety goggles
3		Safety shoes

## 2. Product introduction

The Soluna 10K PACK HV is an NCM-type lithium battery product with a battery management system ('BMS'). This high-voltage BS features CAN communication, as well as under-voltage, over-voltage, over-current, over-temperature and under-temperature protection functions. It is characterised by high energy density, long life, safety and reliability and is environmentally sustainable.

### Features

- 1) Excellent safety performance.
- 2) Long cycle life.
- 3) Support for CAN communication.
- 4) High energy density.
- 5) Excellent BMS.

### Application

- 1) Back-up power.
- 2) Micro-grid.
- 3) Home energy storage system.

### Unpacking the BS

Remove the nails from the wooden case with a claw hammer, open the wooden case and remove the wooden board.

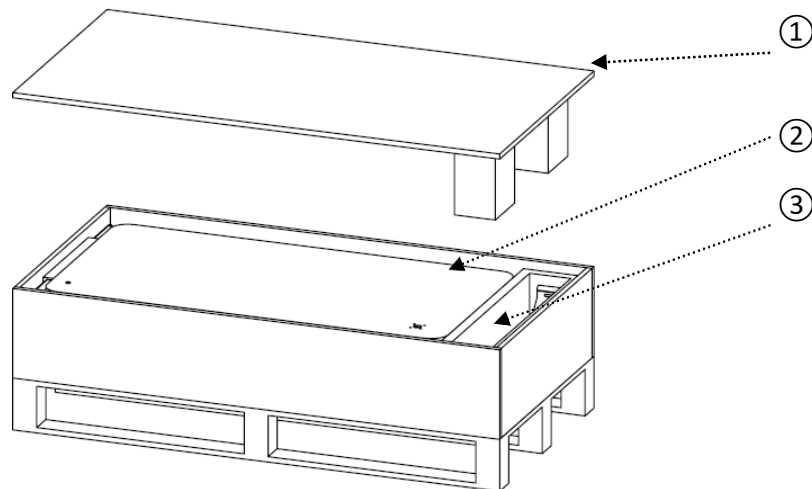

Number	Name	Remark
①	Wooden board	
②	Soluna 10K PACK HV	
③	Accessory box	



Remove the BS from its packaging and stand it upright. Check for visual damage. All other items are contained in a box in one corner of the packaging. Remove them and check whether any items are missing.

**Note:** retain packaging for future storage or transportation.

### Packing list

The following table lists each item and the numbers of these included. If anything is damaged or missing, contact Soluna Australia or your distributor.

Item	Name	Qty (pcs)	Remark
1	Soluna 10K PACK HV	1	
2	Protective earthing conductor (PE wire)	1	
3	Inner-hexagon wrench (3.0)	1	
4	Inner-hexagon wrench (4.0)	1	
5	Inner-hexagon screws (M4)	4	
6	Inner-hexagon screws (M6)	2	
7	Phillips screws (M6)	10	
8	Expansion screws	8	
9	CAN communication wire	1	

### Installation materials

Installers should prepare the following installation materials.

- 1) Battery connection / charging cables
- 2) Network connection cables

### Installation location



Ensure that the installation location meets the following requirements.

- 1) The building is designed to withstand earthquakes.
- 2) The BS location is internal and out of direct sunlight.
- 3) The floor is flat and level.
- 4) There are no flammable or explosive materials nearby.
- 5) The ambient temperature is between 15° and 30° Celsius.
- 6) The temperature and humidity remain at a constant level.
- 7) There is minimal dust and/or dirt in the area.
- 8) There are no corrosive gases present, including ammonia and acid vapour.

	If the ambient temperature is outside the operating range, the BS will stop operating to protect itself. The optimal operating temperature range for the BS is 15° to 30° Celsius. Frequent exposure to harsh temperatures may adversely affect the performance and longevity of the BS.
---	--

## Installation tools

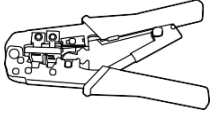
The following tools are required to install the BS.

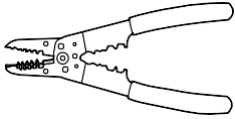
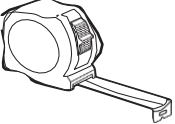
Item	Photo	Name
1		Phillips-screwdriver bit
2		Network crimper
3		Wire cutter
4		Wire stripper
5		Tape measure

All tools should be appropriately insulated to prevent accidental electric shock or short circuits. Use adjustable tools and measuring instruments that are certified for precision and accuracy.

## Outline dimensions (mm)

Figure 2.1 – outline dimensions.

Depth

Width

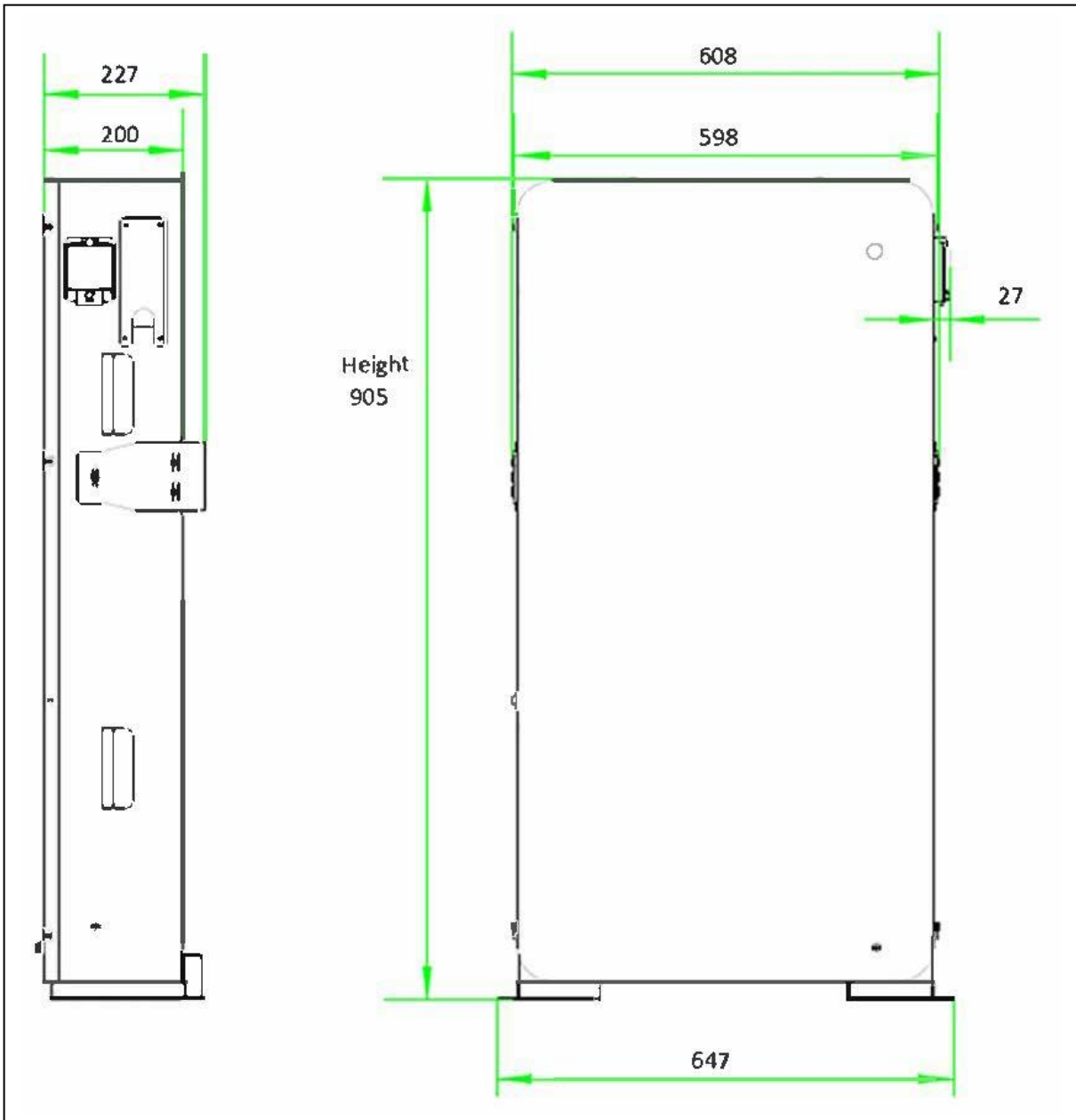

Width (mm)	647 ±2
Depth (mm)	227 ±2
Height (mm)	905 ±3
Weight (kg)	103

## Technical data

### Physical characteristics

Width (mm)	647 ±2
Depth (mm)	227 ±2
Height (mm)	905 ±3
Weight (kg)	103

### Electrical characteristics

Battery type	NCM
Total energy capacity (kWh)	10
Usable energy capacity (kWh)	8
Battery capacity (Ah)	36.6
Voltage range (V)	242 to 327
Nominal voltage (V)	280.8
Charge voltage (CV)	327
Discharge voltage (V)	234
Charge/discharge current (nominal) (A)	15/15
Max. charge/discharge current (A)	30/30
Charge/discharge power (nominal) (kW)	4.2
Max. charge/discharge power (kW)	8
DoD (%)	80
Cycle life	≥3600
Battery pack round-trip efficiency (%)	>95
DC disconnect	Contacteur fuse

### BMS

Power consumption (mA)	≤100 (work), ≤0.1 (sleep)
Monitoring parameters	System voltage, system current cell voltage, cell temp.
Communication	CAN

### Operating conditions

Operating temperature (° C)	-10 to +45
Operating temperature (recommended) (° C)	15 to +30
Storage temperature (° C)	-20 to +60
Humidity (%)	5 to 95
Altitude (maximum) (m)	2,000
Cooling strategy	Natural convection

### Reliability and certification

Certificates	Cell – UL1642; Battery – IEC62619 & UL1973 AS/NZS 60950
Hazardous materials classification	Class 9
Transportation	UN38.3
Ingress rating	IP54

## Appearance

Figure 2.2 – appearance.

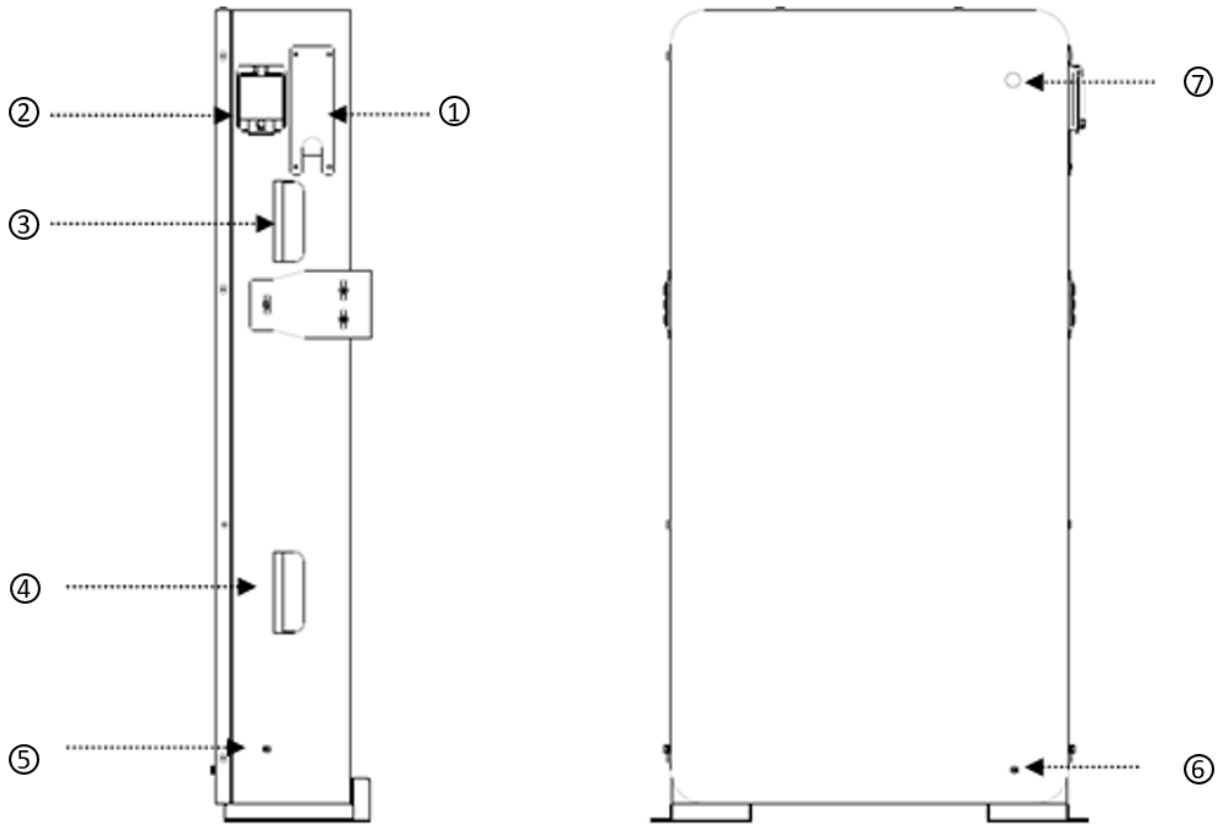

Number	Name	Remark
①	Cable entry	
②	Power ON/OFF	
③	Upper handle	
④	Lower handle	
⑤	Grounding	
⑥	Grounding	
⑦	Power light	

## Wiring port

The Soluna 10K PACK HV's wiring port is visible once the cover cap has been opened (see diagram below for details).

Figure 2.3 – Wiring port.

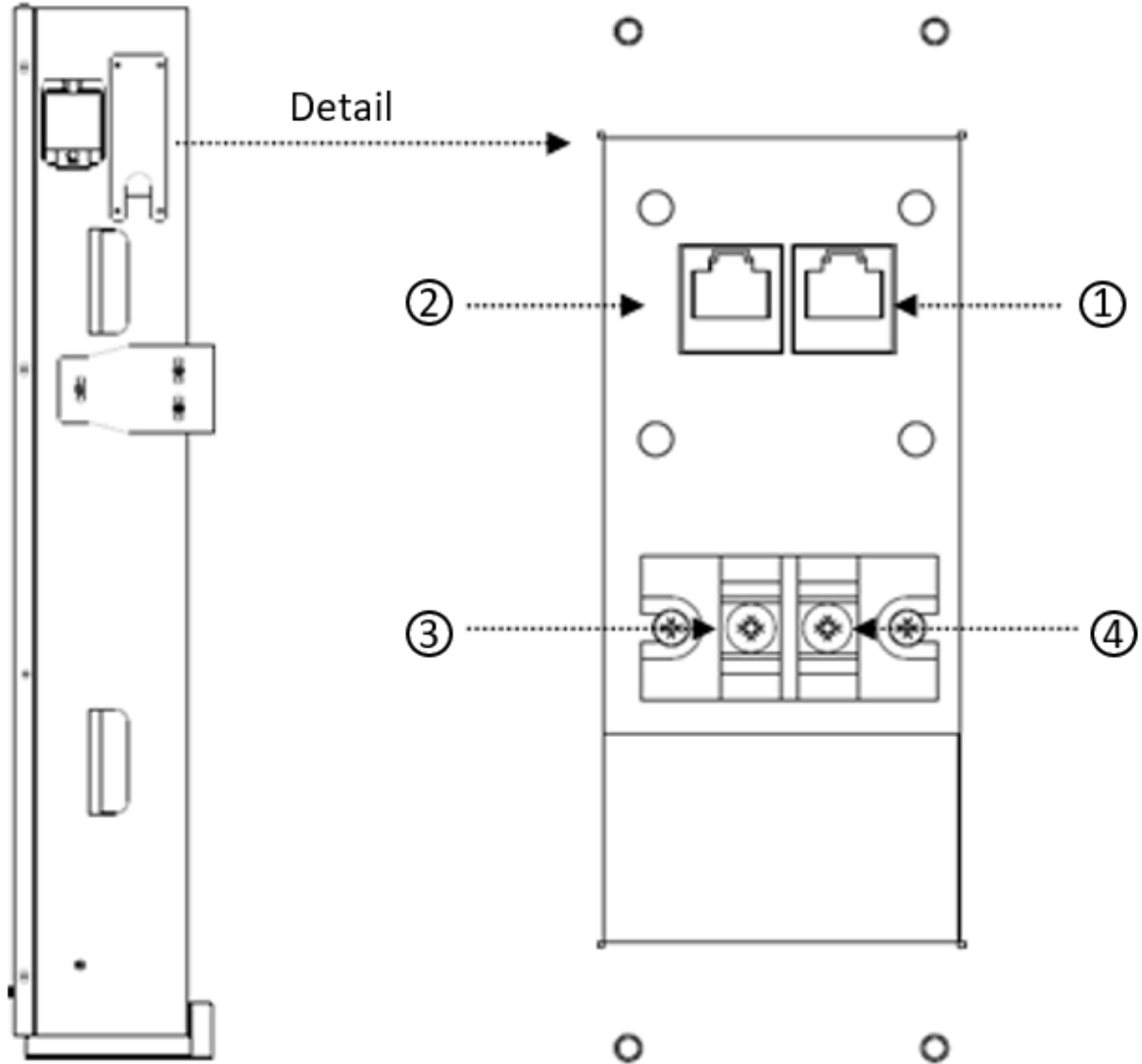

Number	Name	Remark
①	CAN 1 port	For external communication (inverter)
②	CAN 2 port	For internal communication (BMS)
③	Battery '+'	
④	Battery '-'	

### 3. Installation



The BS is too heavy for one person to carry. Ensure that two or more people are available to do so.

**Note:** an external bi-pole circuit breaker is required for battery output. During installation, an external bi-pole DC isolator is required.

#### Space requirements during installation and operation

To ensure adequate ventilation during installation, where possible, allow a space of 200 cm in all directions around the BS.

Position	Minimum spacing (cm)	Remark
Side spacing	100	Allow a clearance of at least 100 cm on either side of the BS.
Above	40	Nothing should be placed on top of the BS – allow clearance of at least 40 cm.
Below		Always use the floor-mounting brackets supplied. Their height is adjustable, allowing the installer to ensure that the BS is level when installed (minimum height is the bottom of the bracket).
Backspacing	10	The BS needs to be installed against a wall.

**Note:** for detailed requirements concerning the width of the maintenance channel, escape routes, etc., refer to applicable standards for the country/region in which the BS is installed.

## Installation requirements

The Soluna 10K Pack HV should be installed against a wall, with eight holes drilled into that wall to fix the BS mounting brackets. See the following diagram for details.

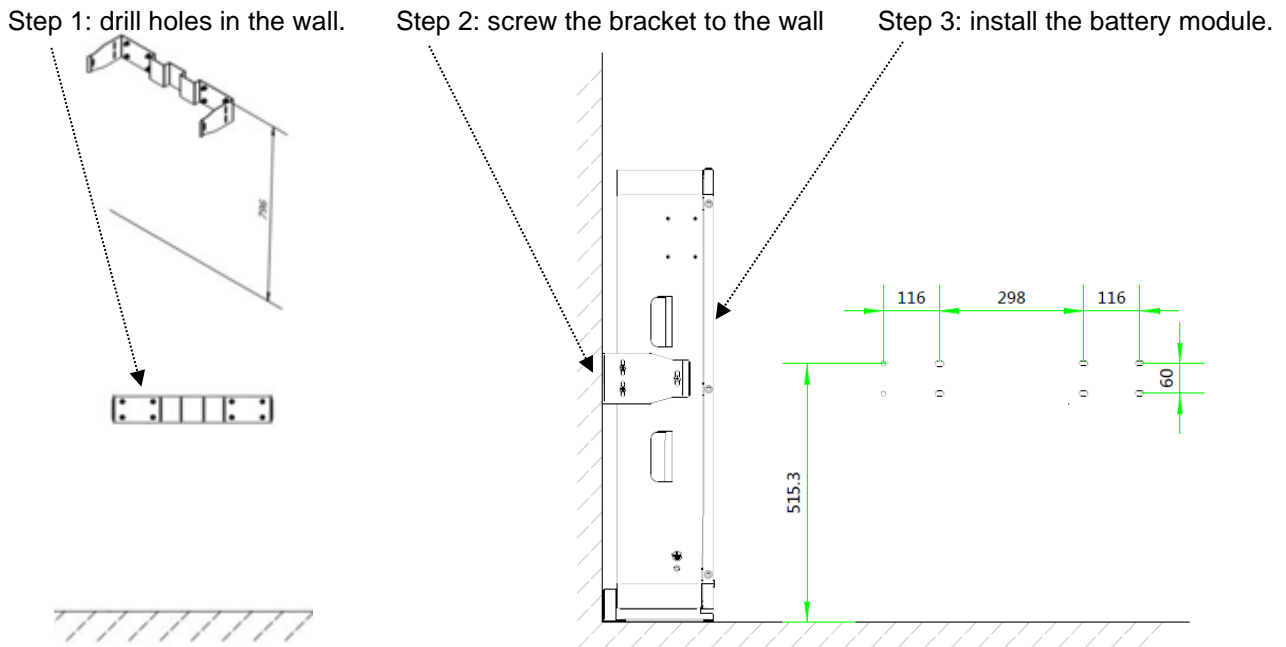

## Wiring specification

To standardise the BS wiring specification, the following are required to connect the wires.

Battery wire	Communication cable
Use of a 10 mm conductor with double insulation is recommended.	Use of communication cable with a shielding function is recommended.

## Earth connection specification

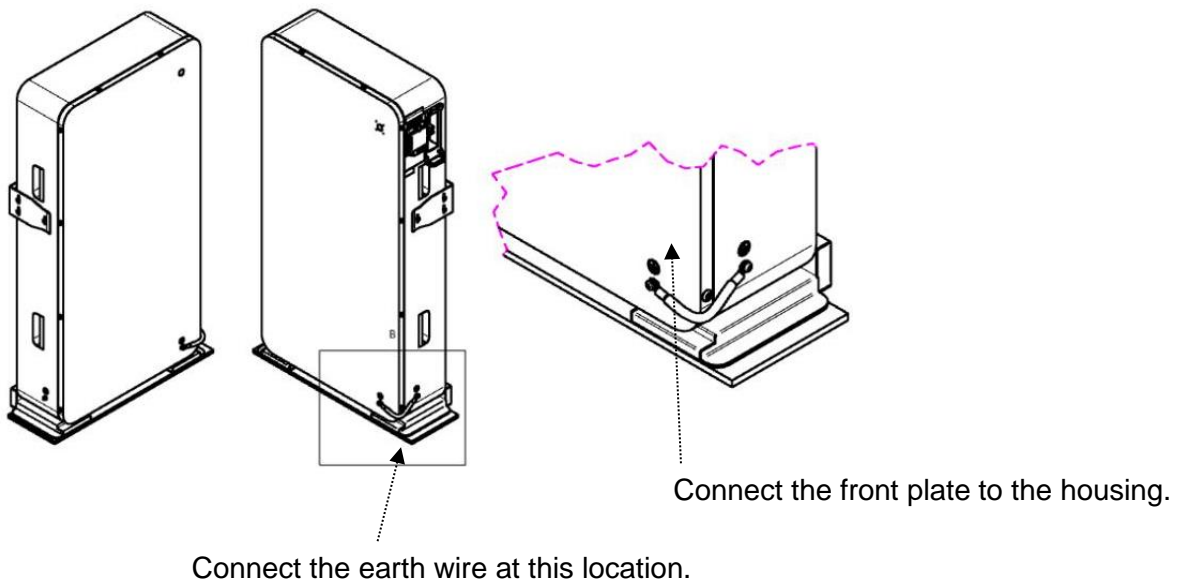



## CAN communication interface (CAN 1 and CAN 2)

Figure 3.1 – CAN interface definition.

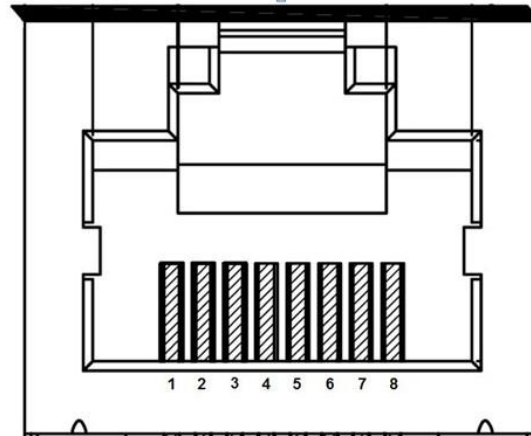

CAN 1 port (for external communication)

1	2	3	4	5	6	7	8
—	—	—	CAN 1H	CAN 1L	—	—	—

CAN 2 port (for internal communication)

1	2	3	4	5	6	7	8
—	—	—	—	—	—	CAN 2H	CAN 2L

**Note:** CAN 1H/CAN 1L used for external communication (inverter); CAN 2H/CAN 2L used for internal communication (battery CAN ports).

## Electrical connection

Please refer to the following diagram for details for double pole isolation of the 10k pack HV battery systems.

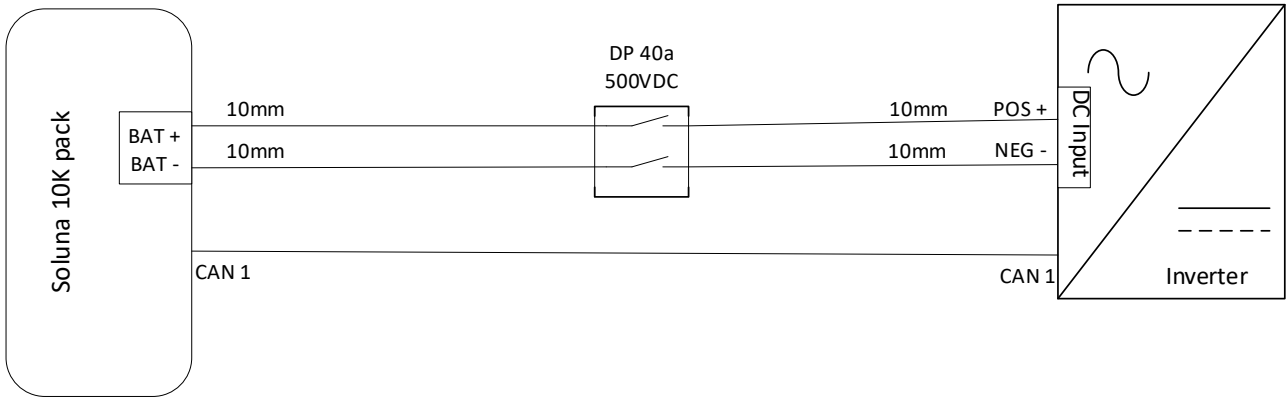

## Preparation

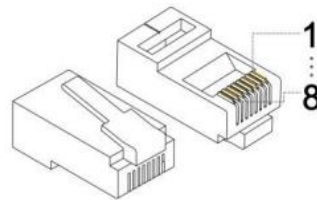
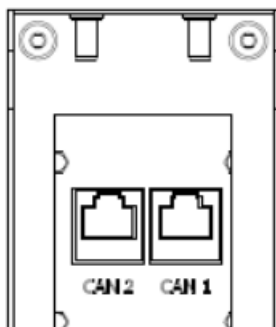

## Electrical connection procedures

**Step 1.** Connect the earth cable.

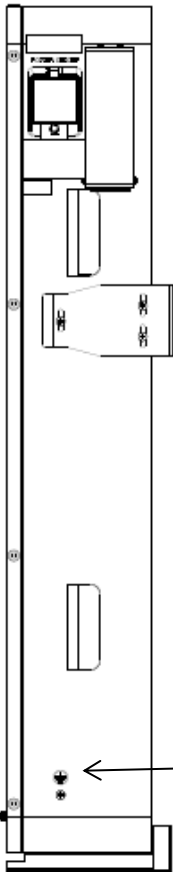

The earth terminal and cable should be fastened with an M6 screw.

**Step 2.** Create power cables.

*Crimp the correct cable lugs 10mm cable x 5mm screw hole.*

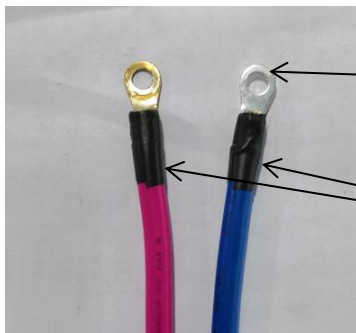

crimp the cable lugs 10mm x 5mm with a wire crimping tool.



Heat-shrink sleeve should be applied to the exposed conductive crimp lug.

**Step 3.** Lock power cables and communication cable.



Remove communication cable from accessory box and plug CAN 1 into the inverter.

Lock power cable with a Phillips screwdriver (M5), ensuring the correct polarity and a firm connection of 3NM torque.

**Step 4.** Lock the cover.



Lock the terminal cover plate with a hexagon wrench (2.5 mm).

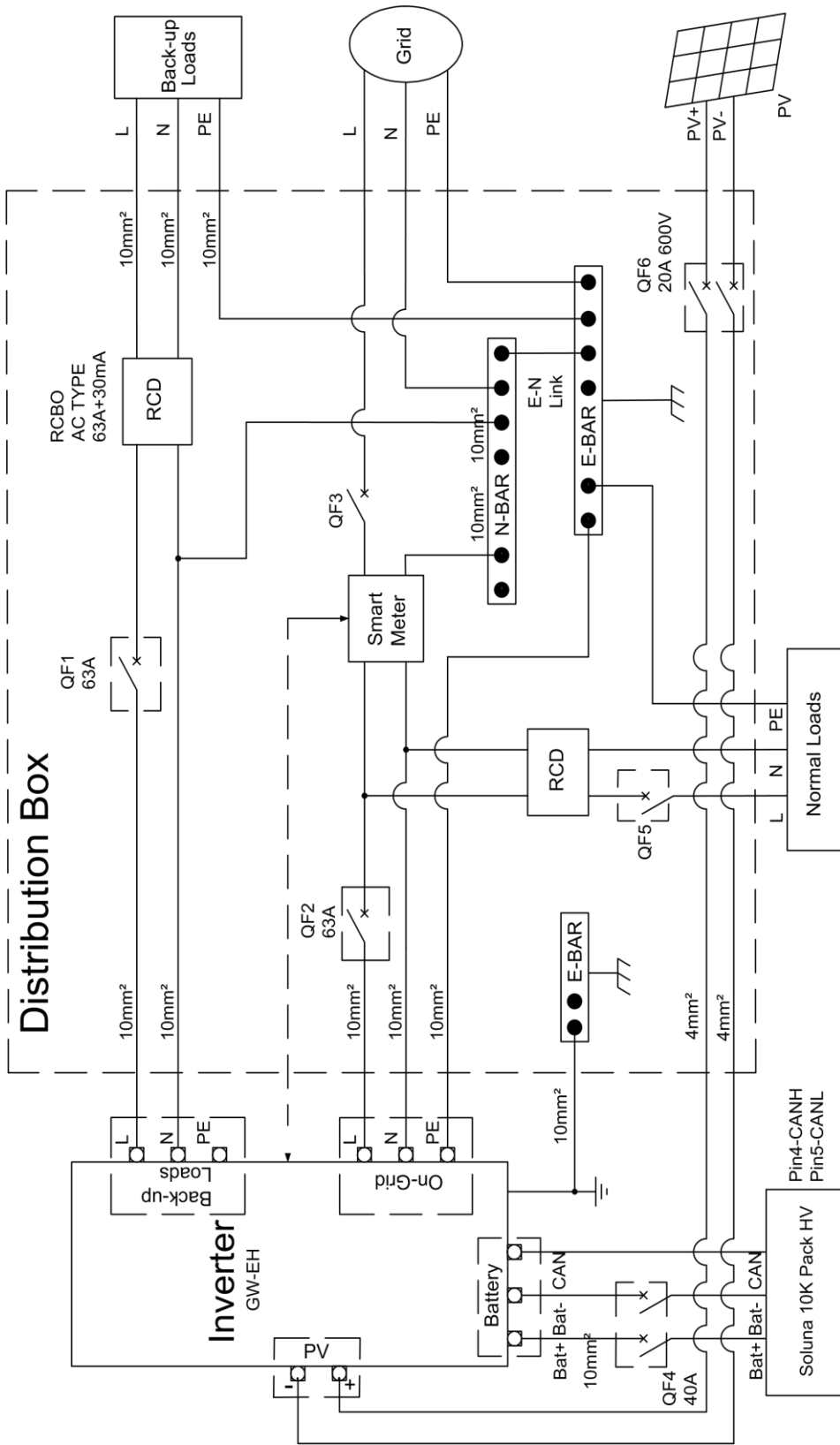

Schematic diagram Soluna 10K pack and Goodwe EH Inverter single phase.

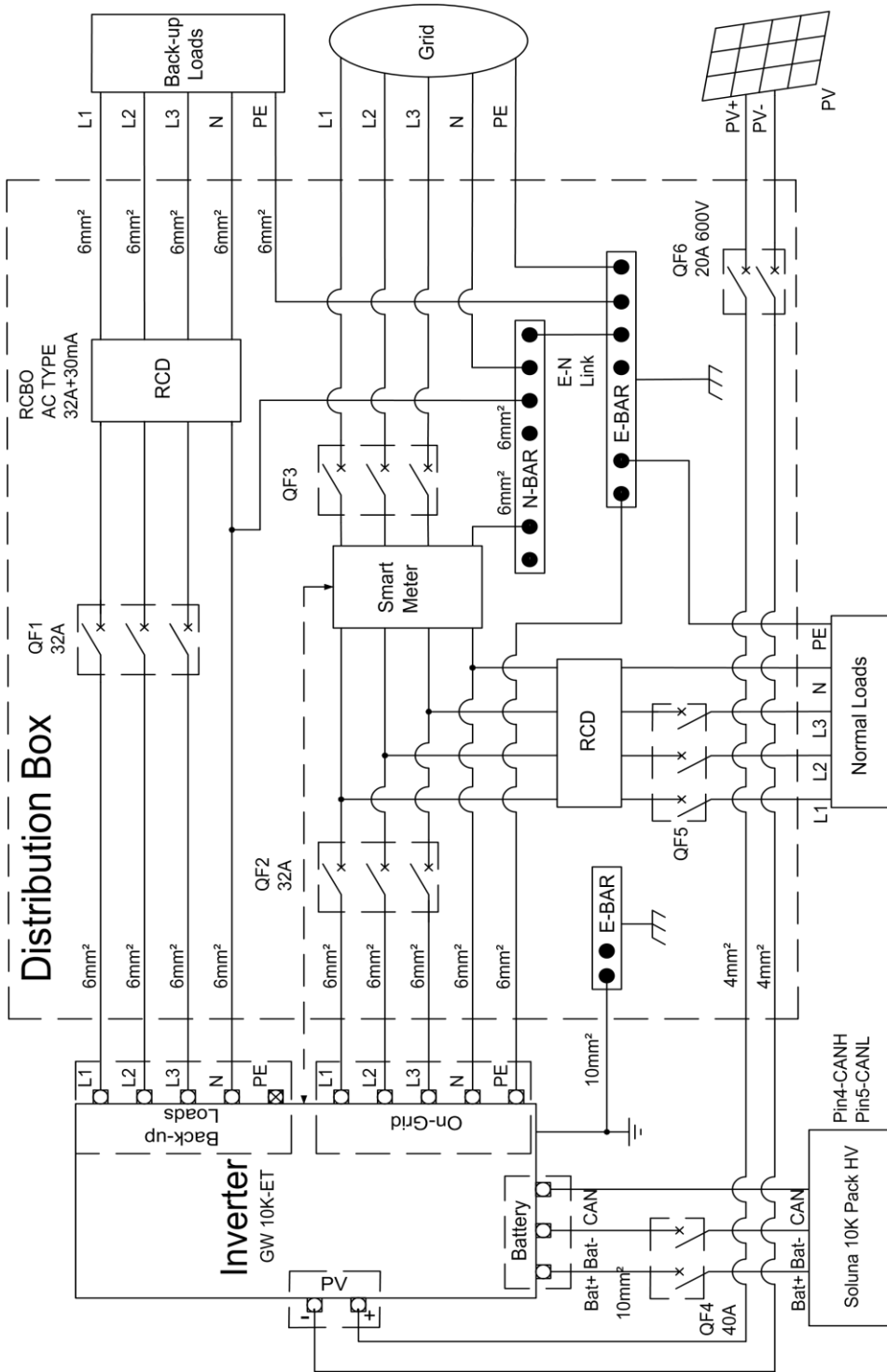

Schematic diagram Soluna 10k pack and Goodwe ET inverter three phase.

## Operating instructions

Please refer to the following diagram for details.

- 1) Connect the inverter and BS with communication wire.
- 2) Connect the inverter and the DC port of the BS with wires.
- 3) Turn on the breaker (on the right side of the BS).
- 4) To shut down, switch off the breaker.

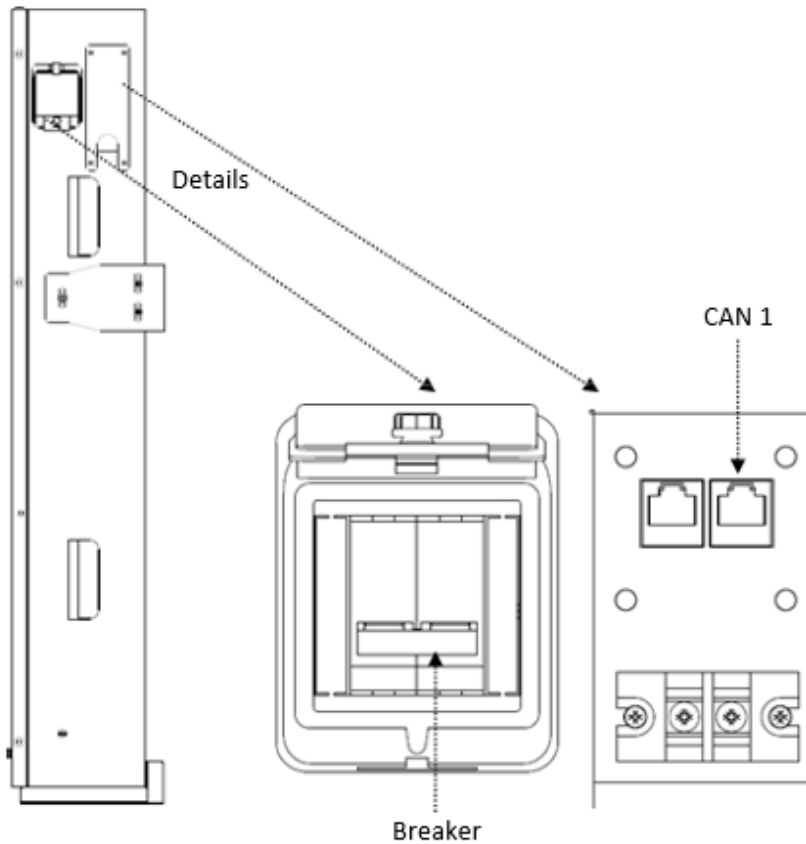

## 4. Consumer 'Start up' and 'Shut down' procedure.

- 1) To turn the BS on, push the breaker up (the breaker is located on the right side of the BS: see diagram above).
- 2) To turn the BS off, push the breaker down.

**Note:** CAN 1 is connected to the inverter for communication.

The circuit breaker is unipolar, Pls see the schematic below for details (the components in the red circle is the circuit breaker).

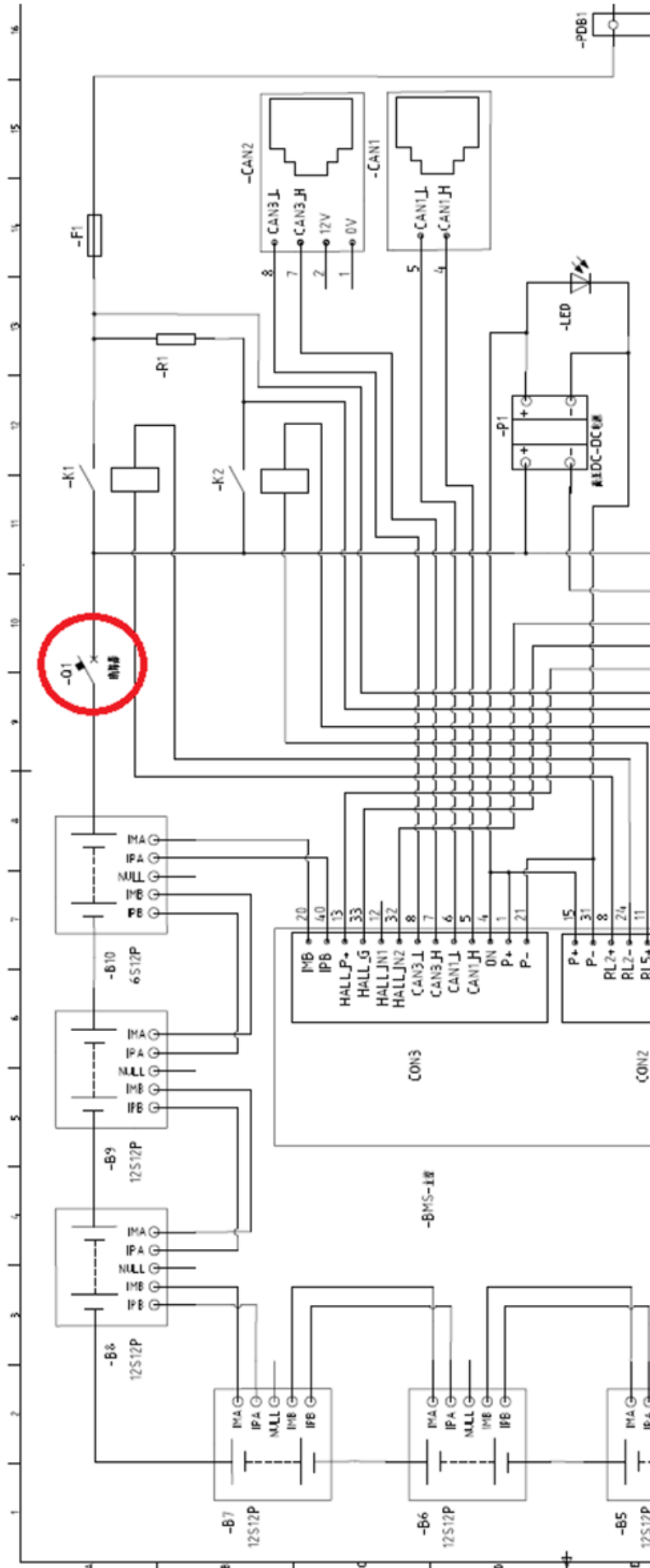



## 5. Care and maintenance

Keep the area around the BS clear of debris.

The Soluna 10K Pack HV BS does not require pre-scheduled preventative maintenance – it is **NOT** designed to be opened. The unit will be replaced if a failure is diagnosed.

### Firmware upgrade

To upgrade the BS firmware, the following are required.

- Laptop (with USB port)
- CAN box
- System password

The following steps should be followed to upgrade the BS firmware (call 1300 126 888 for the username and password (installer only) if required).

- 1) Turn on the power – the power indicator will be lit.
- 2) Plug one side of the CAN box into the CAN 2 port, the other side into the laptop.
- 3) Open the file labelled 'Soluna BMS monitor'.
- 4) In the 'Username' field, enter "\*\*\*\*\*".
- 5) In the 'Password' field, enter "\*\*\*\*\*".
- 6) Click 'Log in'.
- 7) In the upper left-hand corner, click 'CAN converter setup'.
- 8) Click 'Turn on the device'.
- 9) When connected, the screen will show 'BMS successful handshake'.
- 10) Click 'Firmware upgrade'.
- 11) Open the file, choose '10K BMS' then click 'Automatically reset' after download.
- 12) Click 'Start downloading'.
- 13) The installation of the firmware is complete when 'Download successful' appears.
- 14) If there are any issues, please contact Soluna Australia on 1300 126 888.

## 6. Troubleshooting

Check the indicators on the front of the BS to determine its status.

A warning state is triggered when a condition such as voltage, current or temperature has exceeded design limits.

The BMS of the BS periodically reports its operating state to the inverter. When BS operating conditions are outside prescribed limits, the BMS enters a warning state. When a warning is reported, the inverter immediately ceases to operate. The monitoring software on the inverter can be used to identify the cause of the warning. Possible warning messages are as follows.

- 1) Battery Over Voltage
- 2) Battery Under Voltage
- 3) Battery Over Temperature
- 4) Battery Under Temperature
- 5) Battery Discharge Over Current
- 6) Battery Charge Over Current

Any warning messages are cleared when the BS returns to normal operation.

## 7. Contact us

If you have any questions, please contact us.

Phone:	Within Australia	1300 126 888
	Outside Australia	+64 9886 9685
Email	<a href="mailto:service@soluna.com.au">service@soluna.com.au</a>	
Web	<a href="http://www.soluna.com.au">www.soluna.com.au</a>	
Head office	1/677 Murray Street Perth WA 6005	